

**INTERNATIONAL
PRACTICAL SHOOTING
CONFEDERATION
TARGET ARRAY BOOK**

JANUARY, 2019 EDITION

International Practical Shooting Confederation
PO Box 15661
1001 NA Amsterdam
The Netherlands

Tel: +31 20 2440600 Fax: +31 20 2440601
Email: iroa@ipsc.org Web: www.ipsc.org

Copyright © 2019 International Practical Shooting Confederation

SECTION 1: Individual Targets

- 1.1** When **cutting** scoring paper targets or no-shoots, only the lower portion, or a diagonal portion, or one of the sides can be cut, and a replacement non-scoring border must be fitted (see Rule 4.2.3.2):

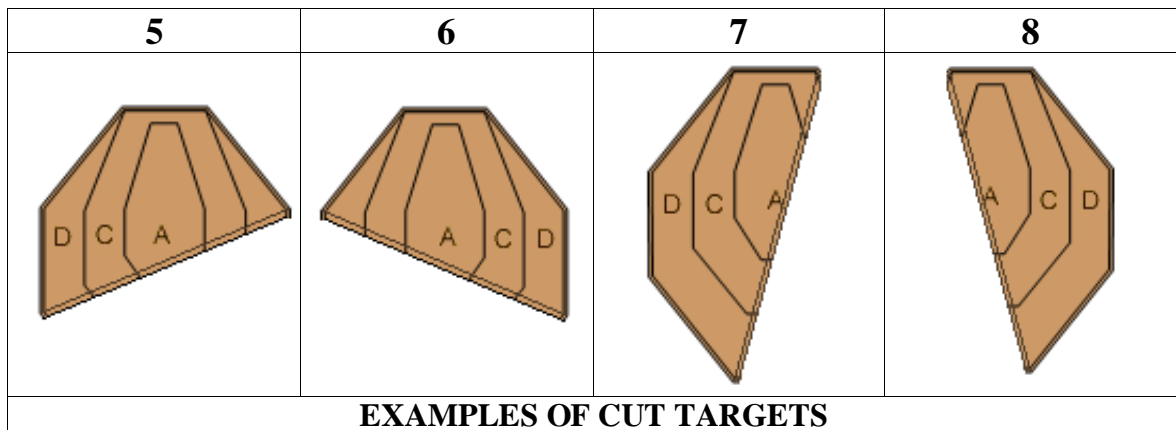
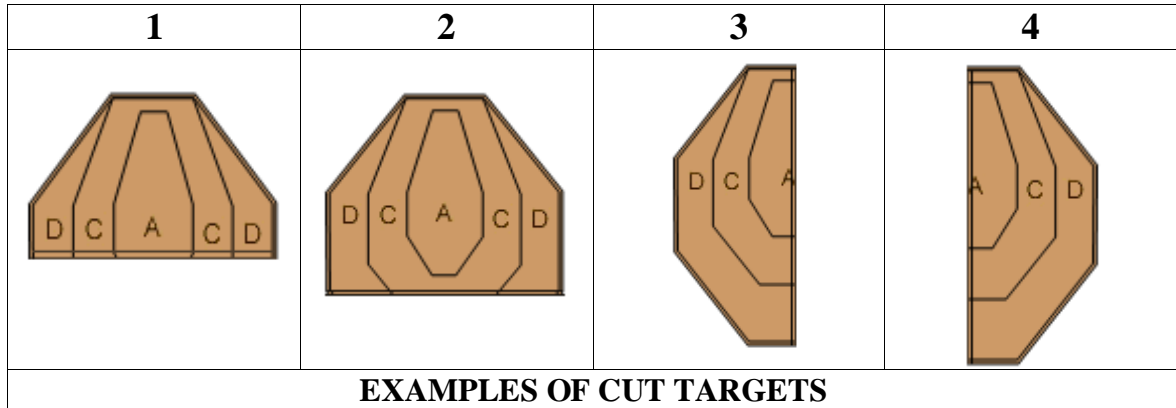

1.2 When **painting** scoring paper targets or no-shoots, only the lower portion, or a diagonal portion, or the sides can be painted. A replacement non-scoring border is not necessary, but the use of tape to create a sharply defined boundary of the Hard Cover is recommended (see Rule 4.2.3.3):

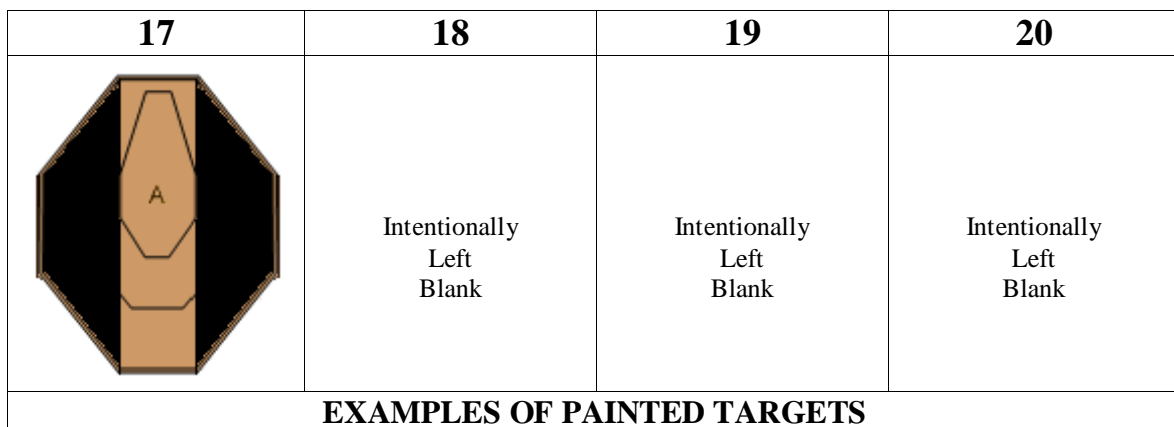
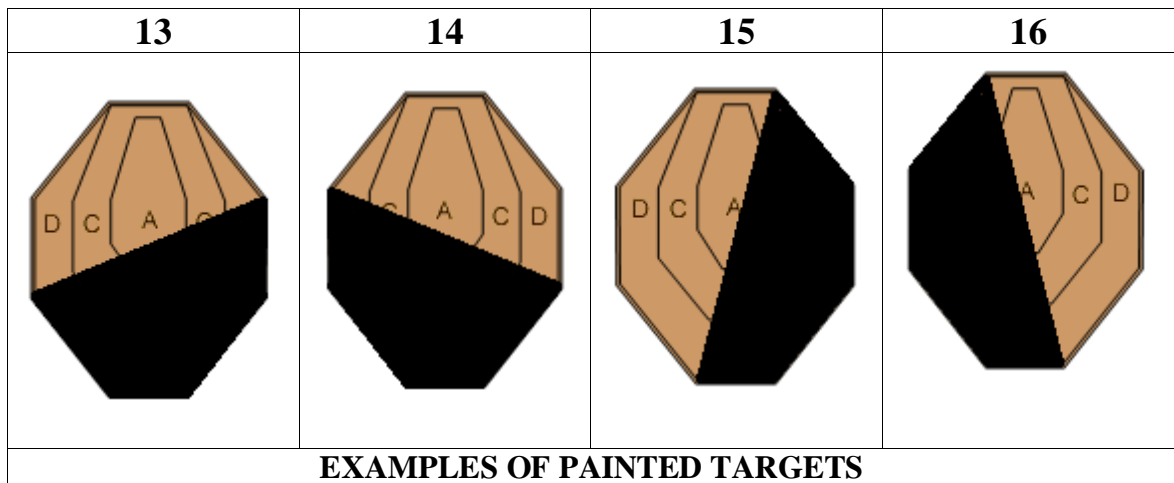
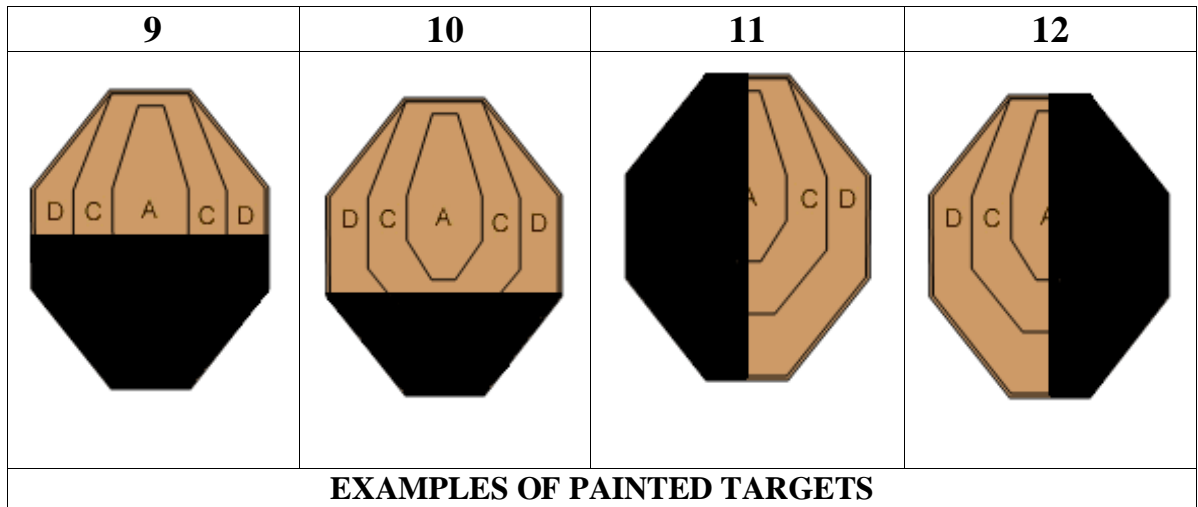

1.3 If a single target is cut vertically to represent two targets, the two pieces must be placed at least 1 m apart. However, a scoring target may be painted with a vertical strip of Hard Cover, provided it is not treated as more than a single target (see Rule 4.1.5):

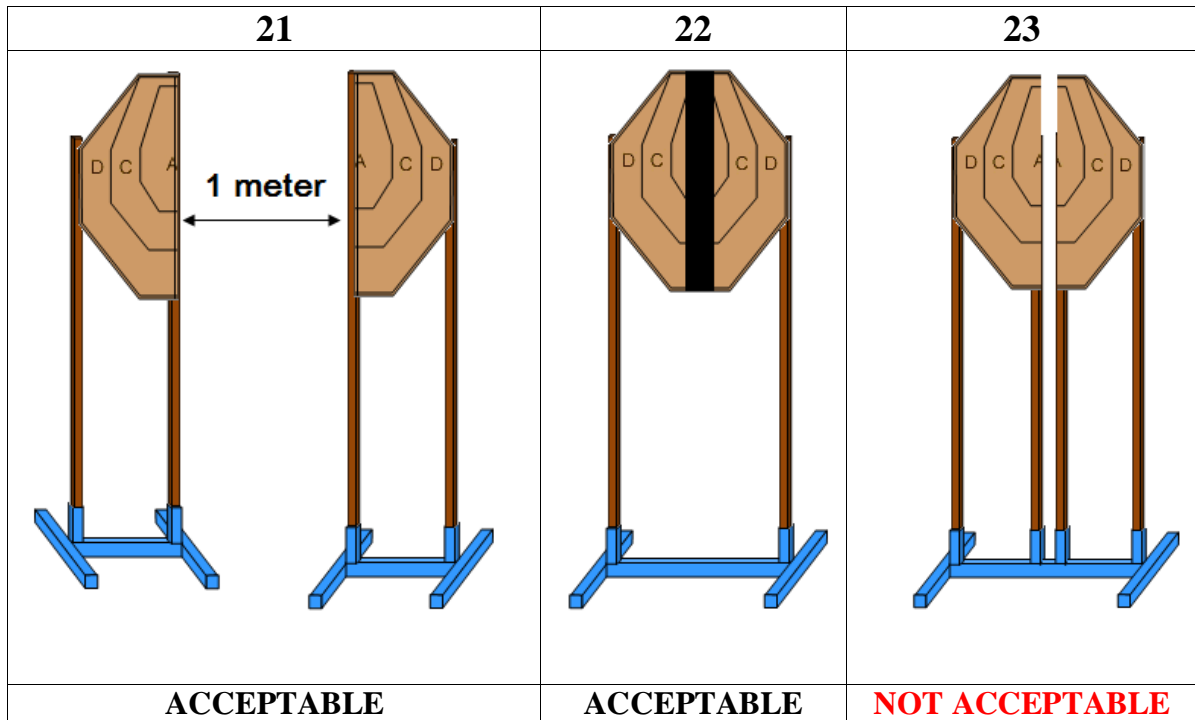

1.4 A portion of one scoring target or no-shoot must not be placed within the boundaries of another scoring target or no-shoot, and a scoring target or no-shoot must not be hollowed:

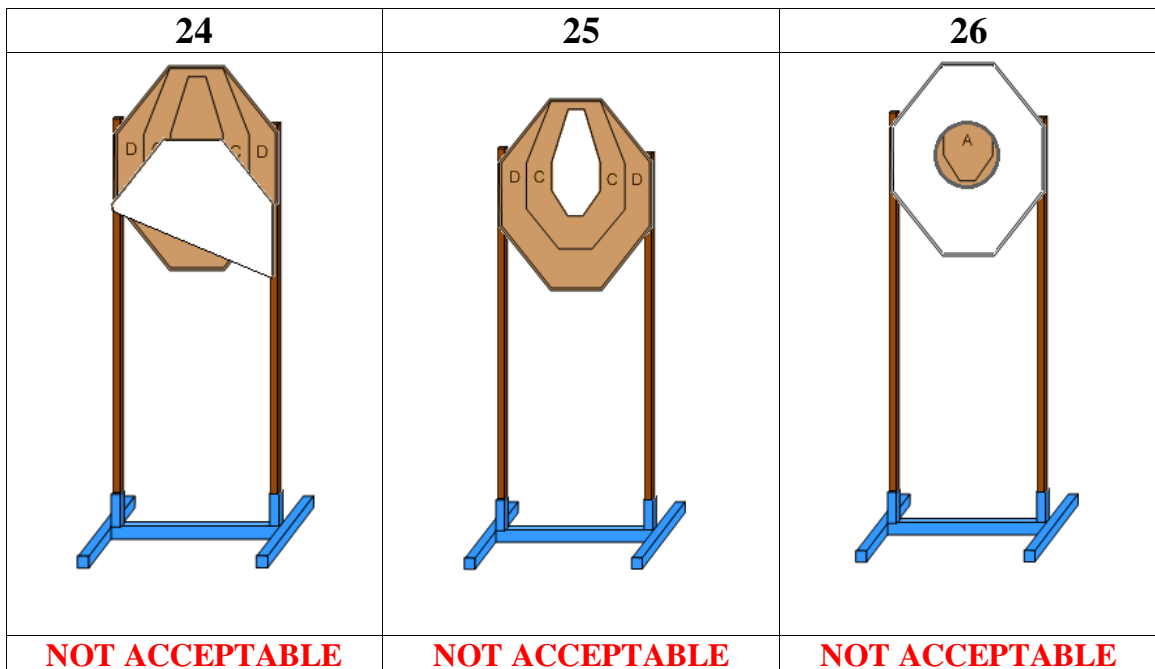

1.5 The top of the IPSC Target or No-shoots must never exceed 1.8m in height and Mini Target or Mini No-shoots must never exceed 1.6m in height.

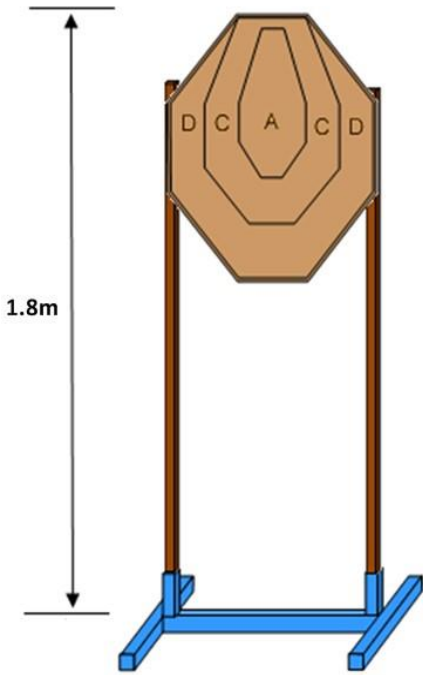
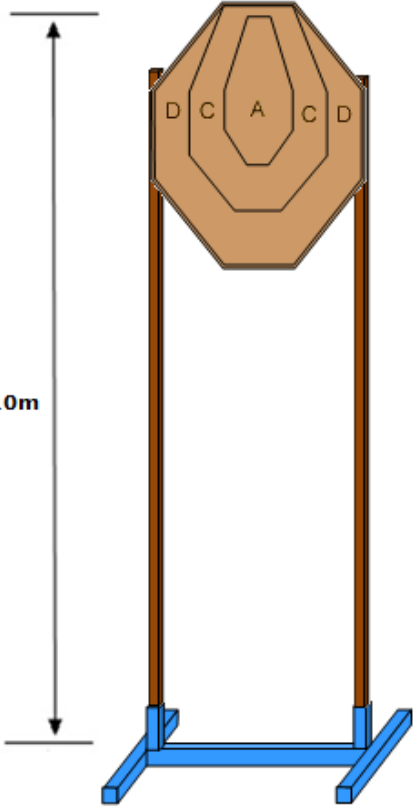
27	28
 <p>1.8m</p>	 <p>2.10m</p>
ACCEPTABLE	NOT ACCEPTABLE

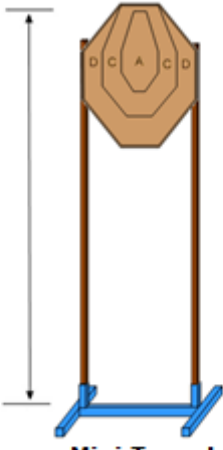
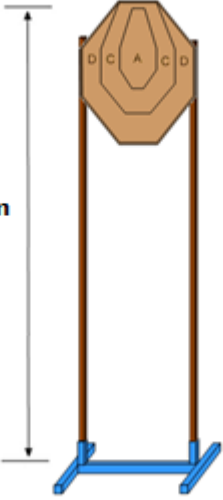
29	30
 <p>1.6m</p> <p>Mini Target</p>	 <p>1.90m</p> <p>Mini Target</p>
ACCEPTABLE	NOT ACCEPTABLE

SECTION 2: Multiple Paper Targets

2.1 The upper portion of scoring paper targets or no-shoots must never be removed or concealed:

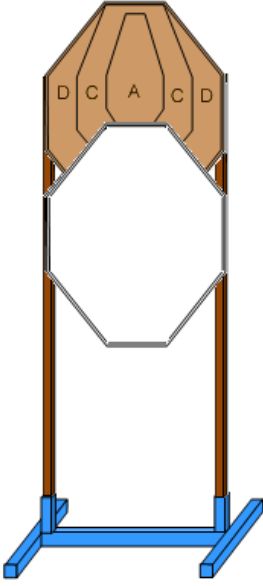
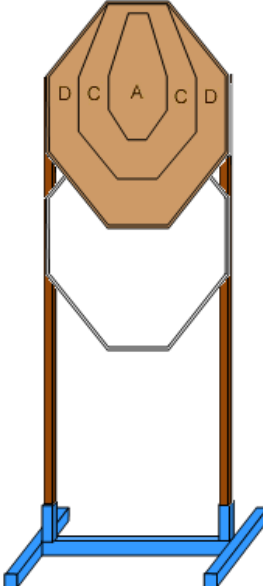
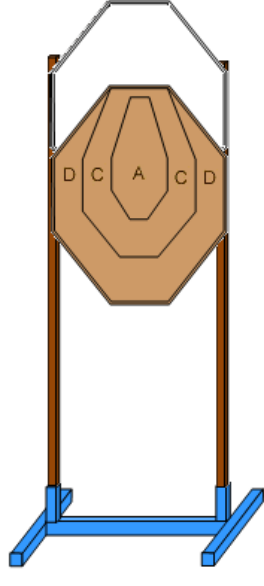
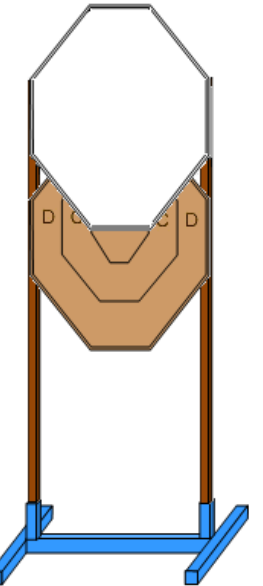
<p>31</p> 	<p>32</p> 	<p>33</p> 	<p>34</p> 
ACCEPTABLE	NOT ACCEPTABLE	ACCEPTABLE	NOT ACCEPTABLE

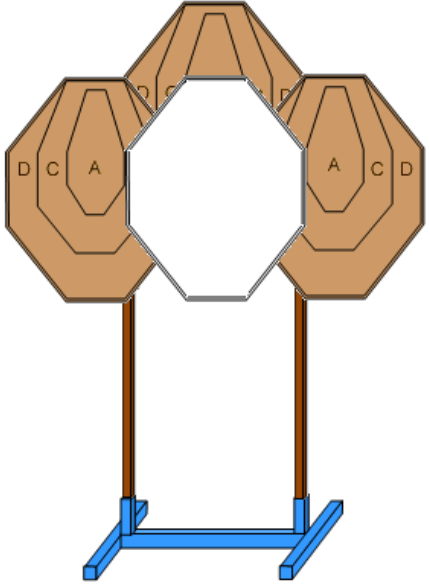
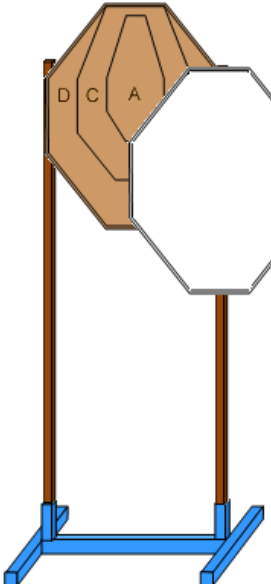
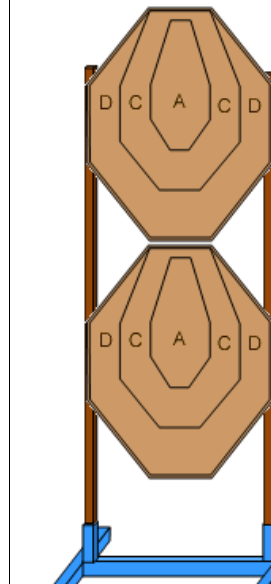
<p>35</p> 	<p>36</p> 	<p>37</p> 
ACCEPTABLE	ACCEPTABLE	ACCEPTABLE

2.2 Whole paper targets must not be used as Hard Cover (see Rule 4.1.4.1). To segregate two adjacent scoring targets, use a no-shoot:

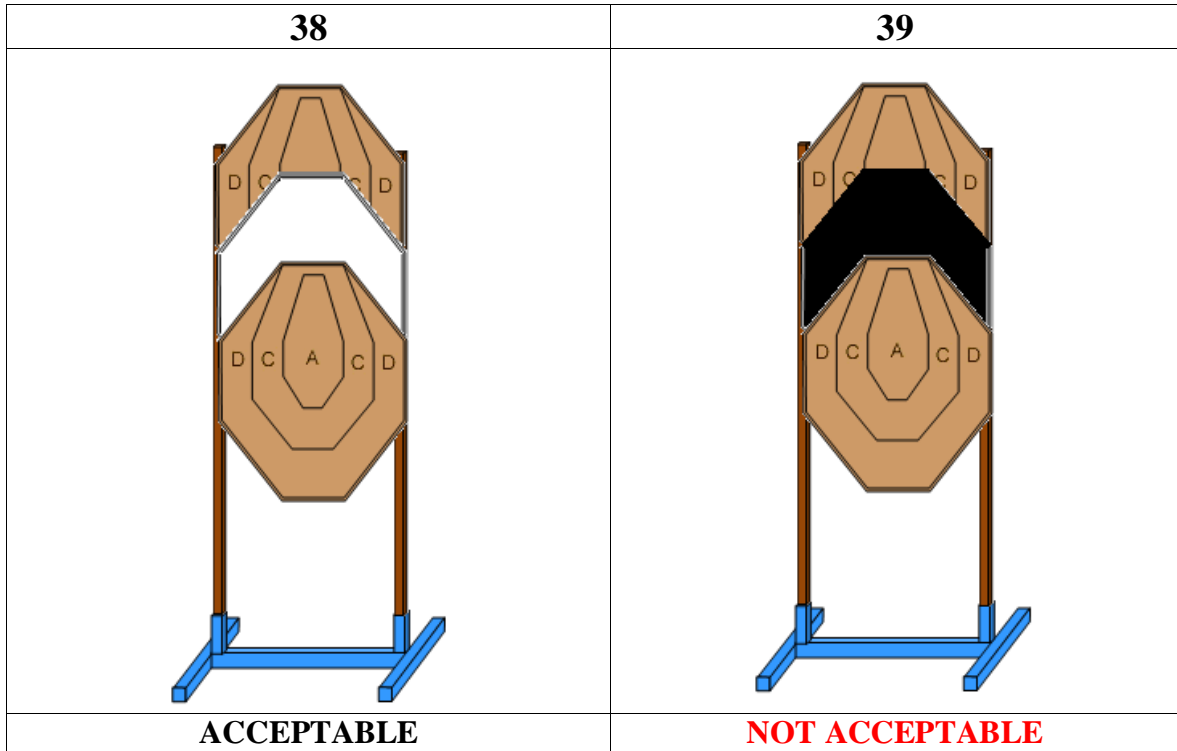

2.3 A no-shoot may be placed to the forward or to the rear of two adjoining scoring targets:

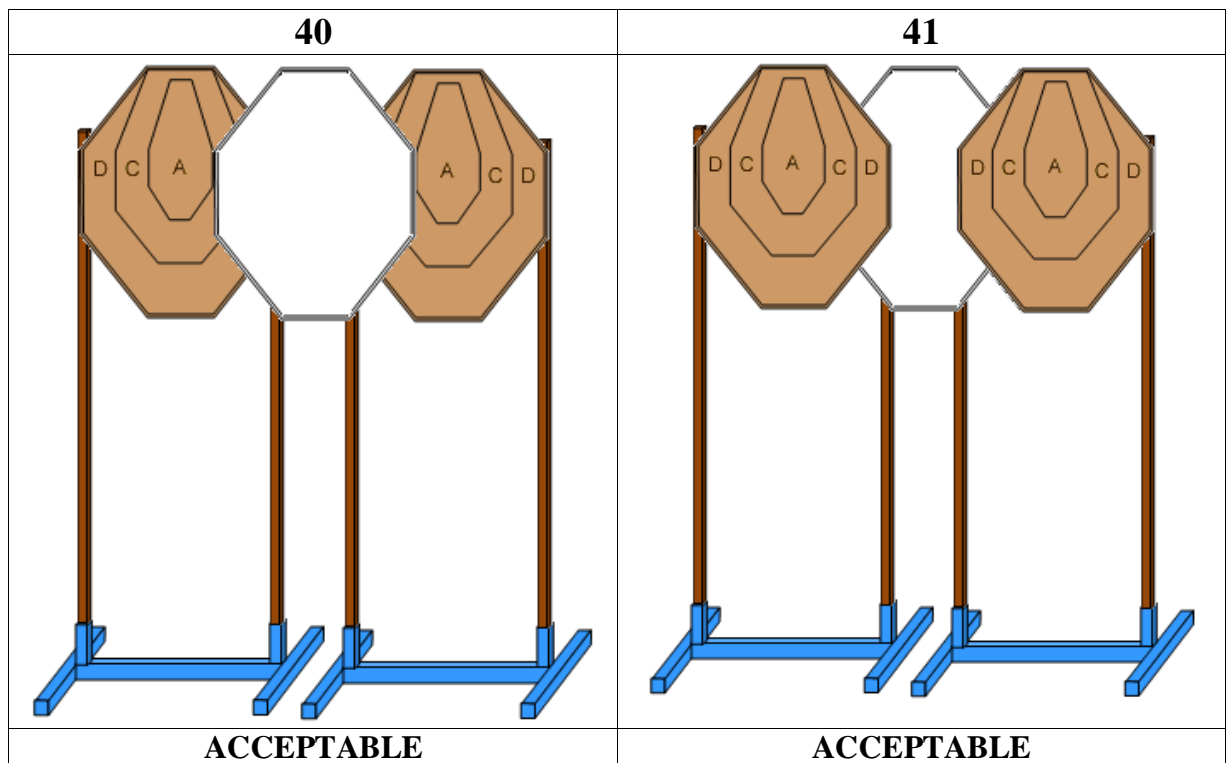

2.4 Overlapping paper targets can be comprised of just two scoring targets, or two scoring targets with a no-shoot separating them:

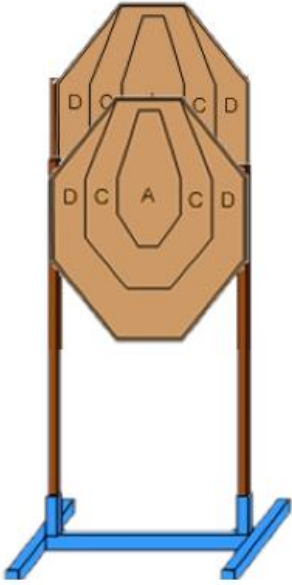
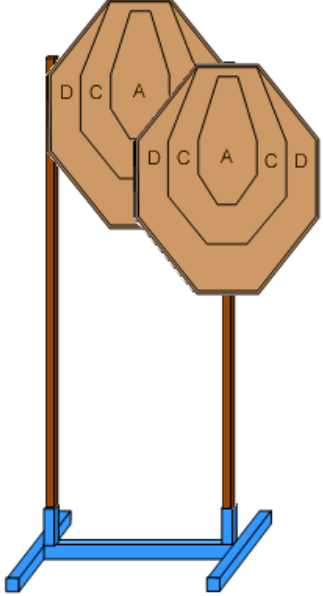
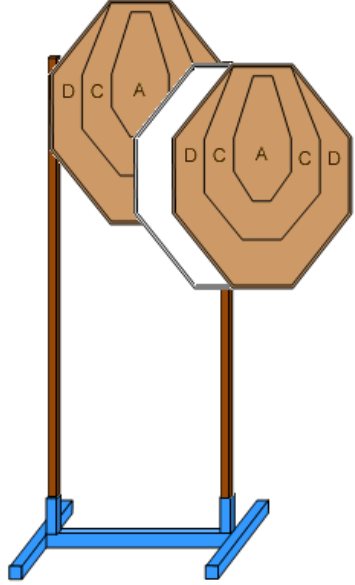
42	43	44
		
ACCEPTABLE	ACCEPTABLE	ACCEPTABLE

2.5 Target arrays which are illogical or impractical, or which are overly complicated, thereby making them difficult to replace consistently for the duration of a match, will not be ACCEPTABLE:

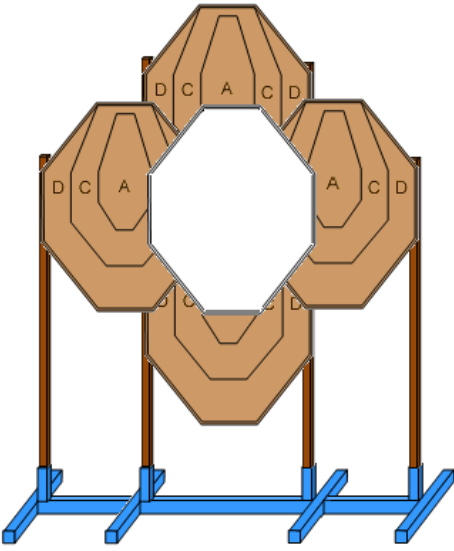
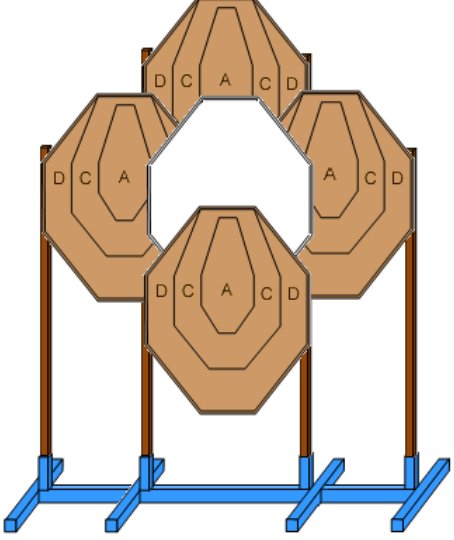
45	46
	
NOT ACCEPTABLE	NOT ACCEPTABLE

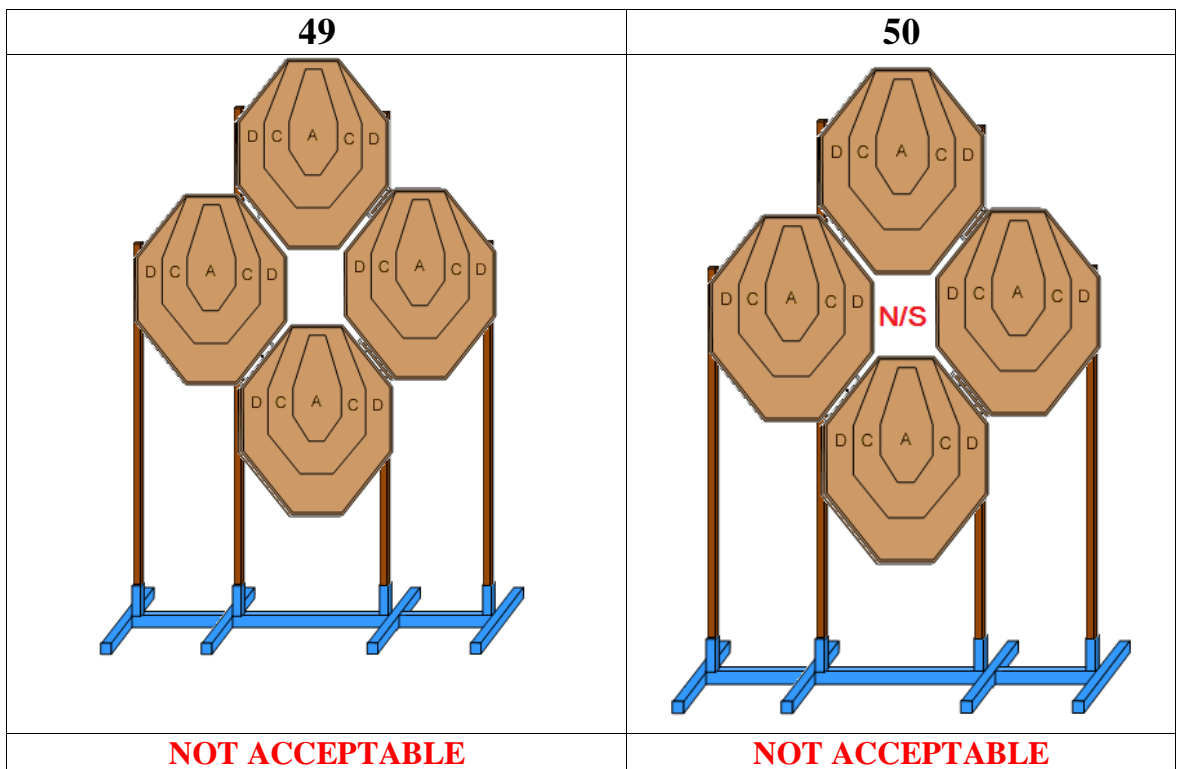
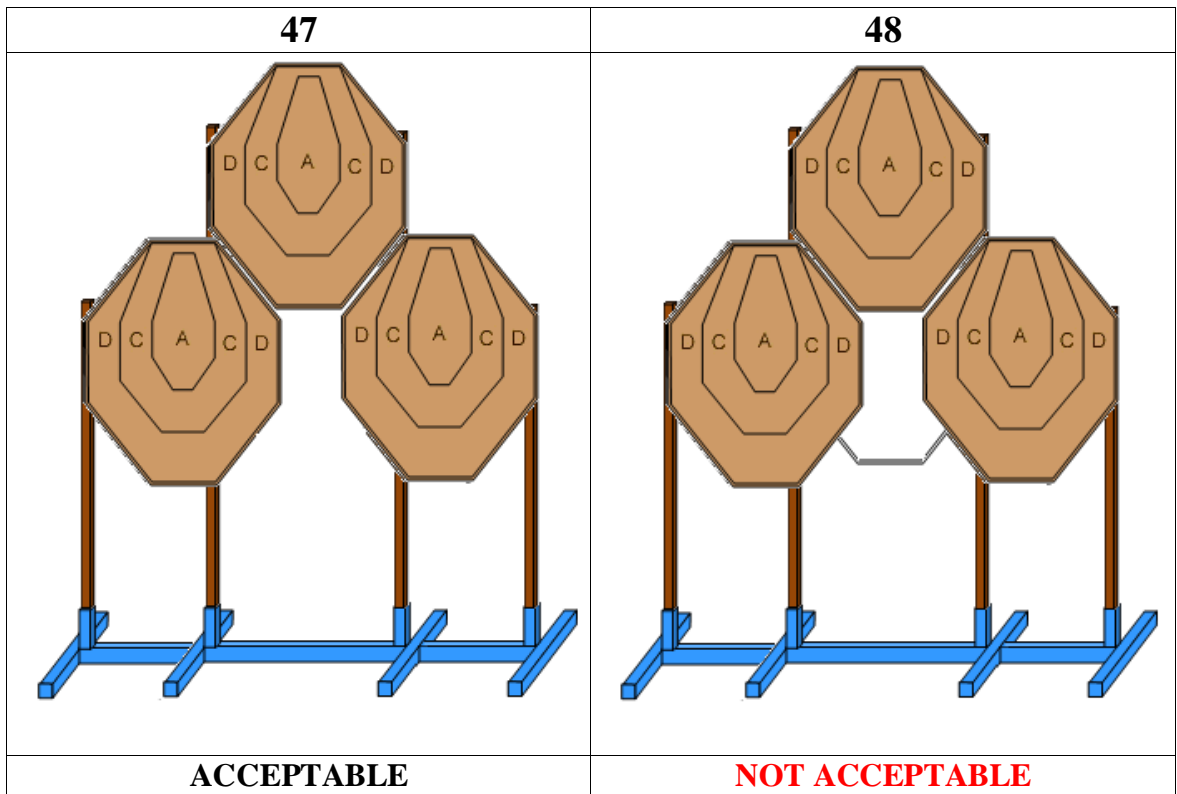

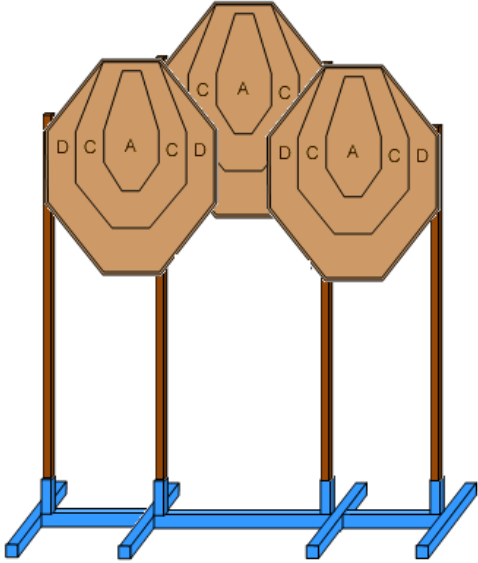
51	52
	<p data-bbox="1098 427 1238 517">Intentionally Left Blank</p>
<p data-bbox="466 837 692 871">ACCEPTABLE</p>	

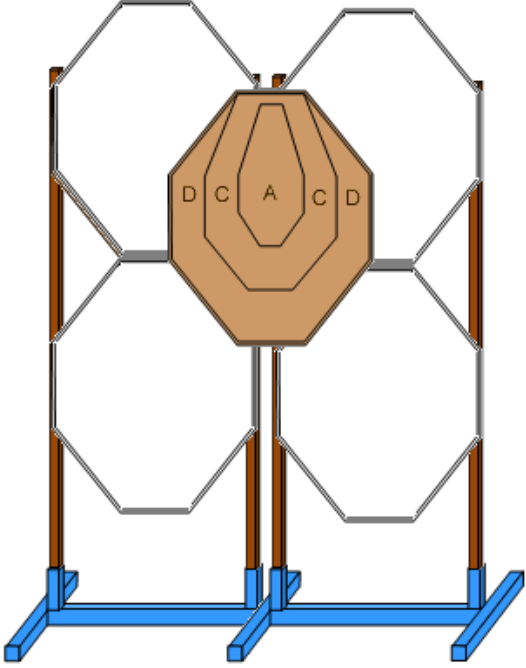
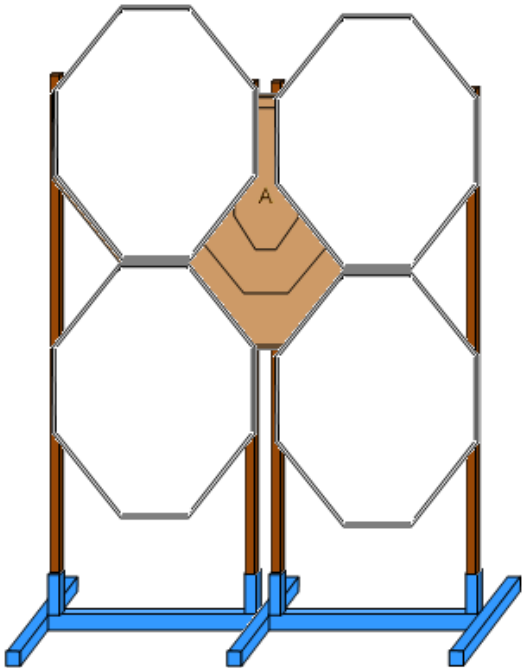
53	54
	
<p data-bbox="408 1816 713 1848">NOT ACCEPTABLE</p>	<p data-bbox="995 1816 1300 1848">NOT ACCEPTABLE</p>

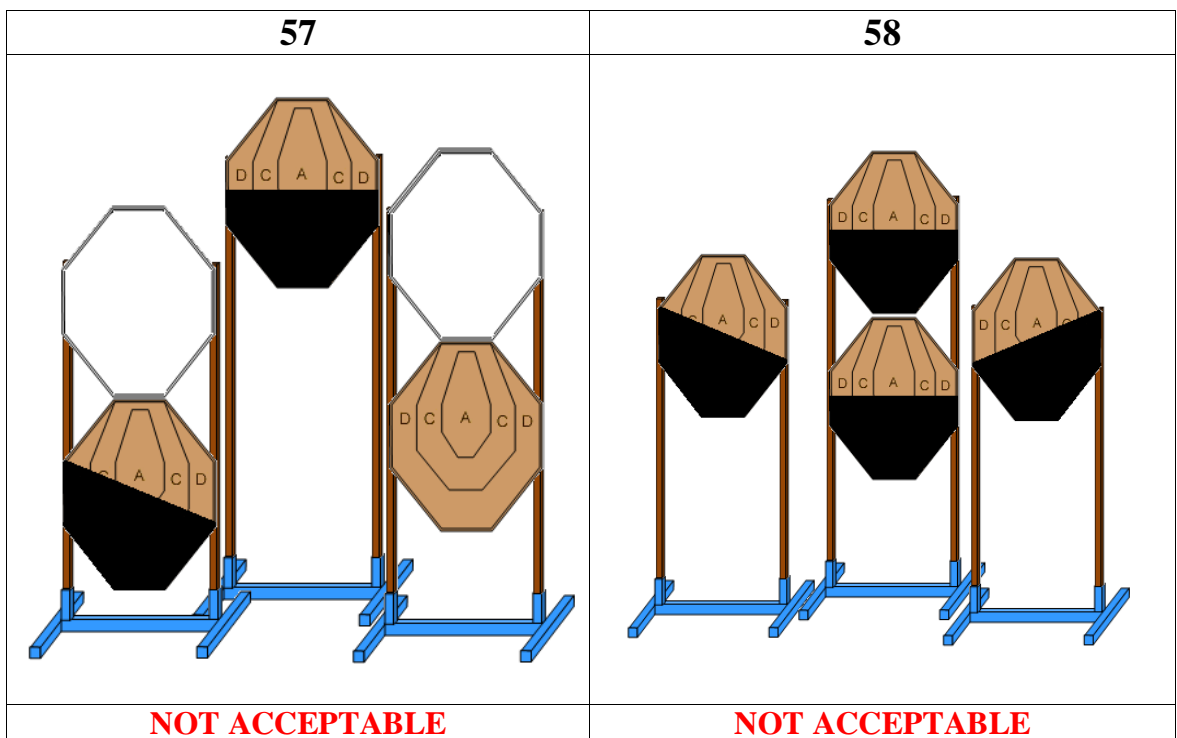
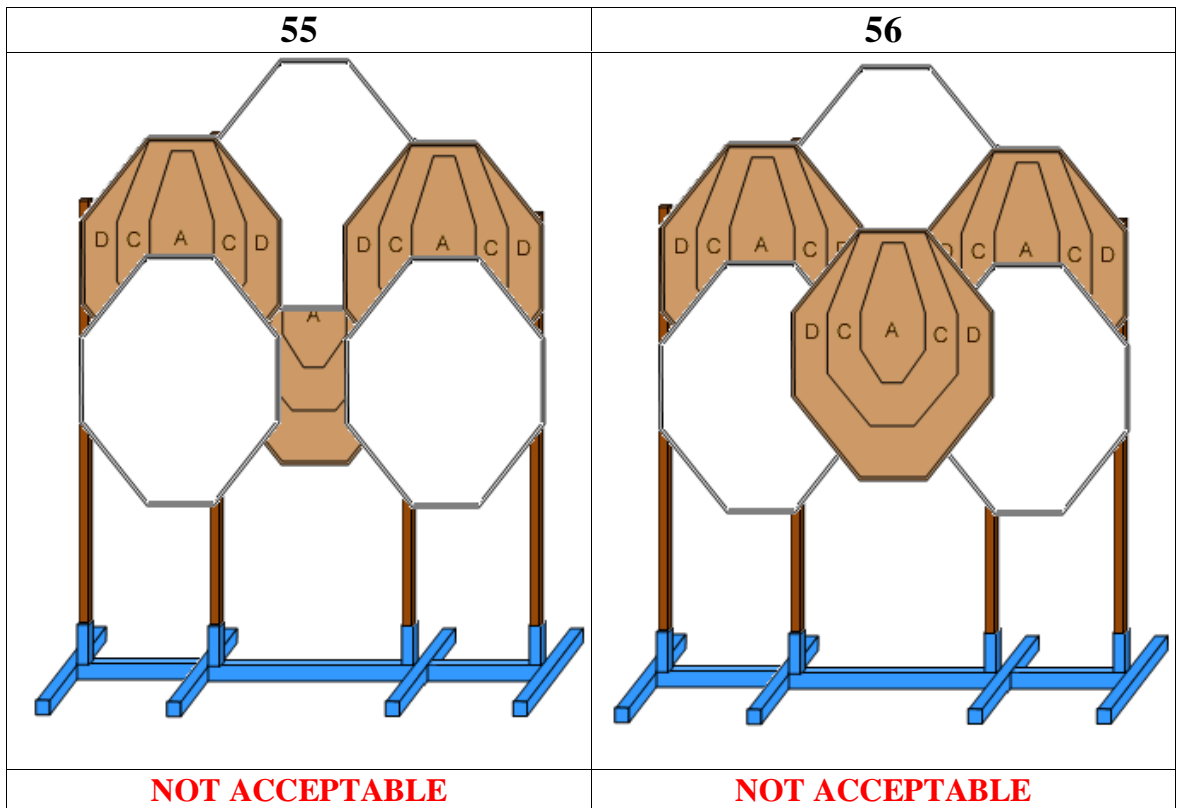

SECTION 3: Mixing Paper & Metal Targets

3.1 When mixed together, paper and metal targets must offer a practical presentation:

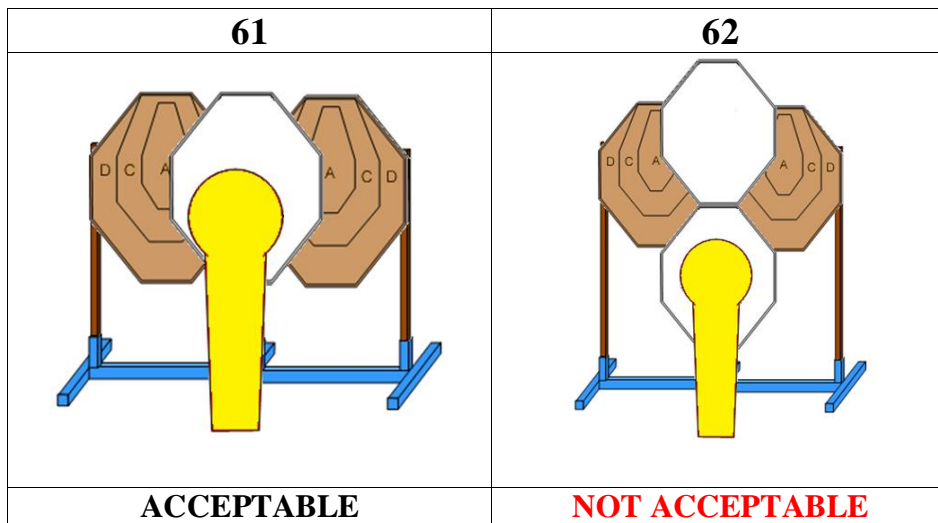
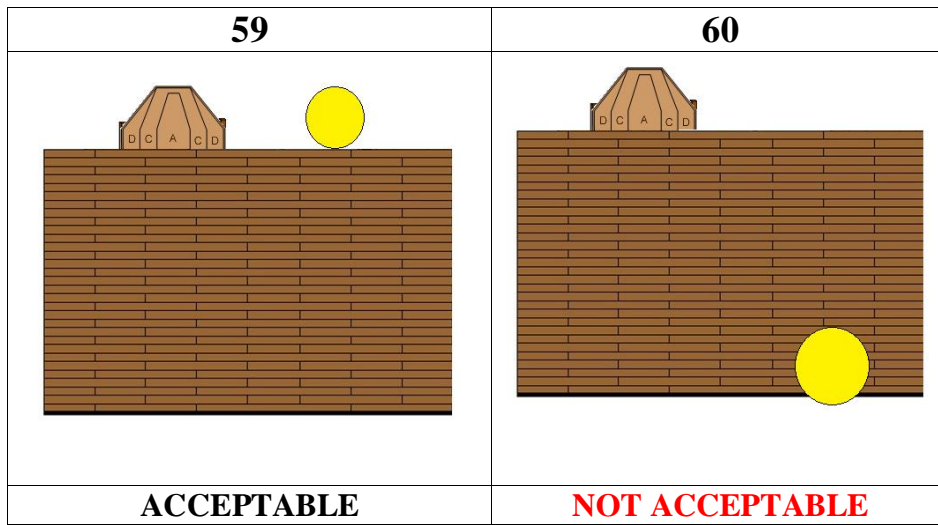

SECTION 4: Carnival Target Arrays

4.1 Target arrays such as "stars", "plate racks", "trees", and similar devices are NOT ACCEPTABLE. However, up to 2 authorized plates, presented above a sturdy common base, may be ACCEPTABLE.

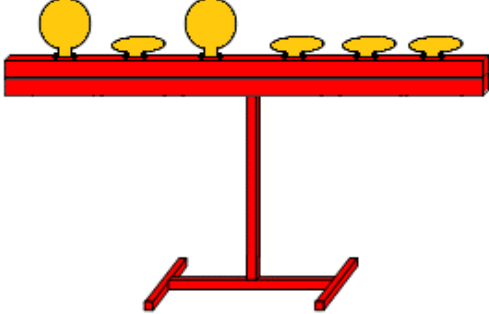
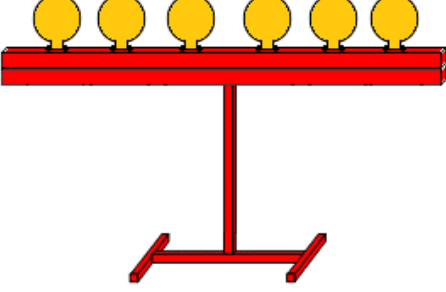
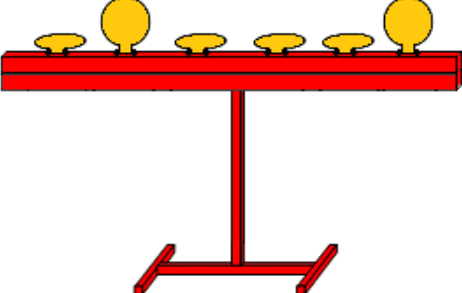
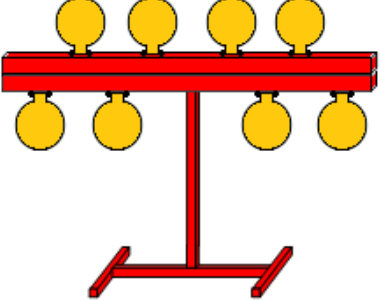
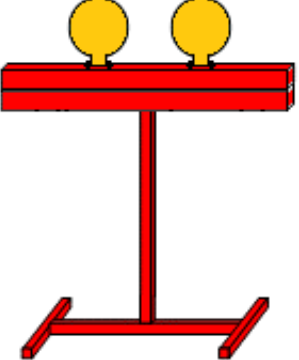
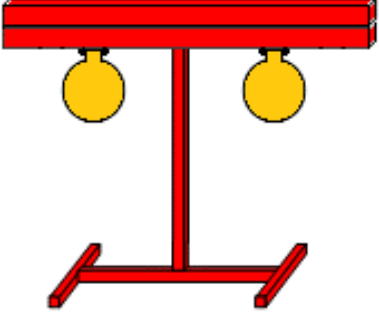
<p>63</p>  <p>ACCEPTABLE (any combination of 2)</p>	<p>64</p>  <p>NOT ACCEPTABLE</p>
<p>65</p>  <p>ACCEPTABLE (any combination of 2)</p>	<p>66</p>  <p>NOT ACCEPTABLE</p>
<p>67</p>  <p>ACCEPTABLE</p>	<p>68</p>  <p>NOT ACCEPTABLE</p>

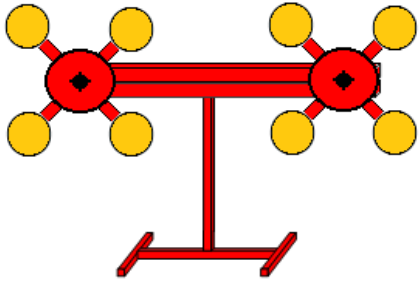
69	70
	<p>Intentionally Left Blank</p>
NOT ACCEPTABLE	

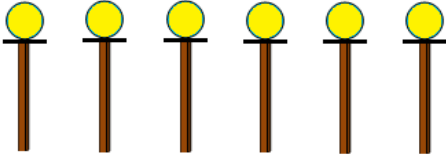
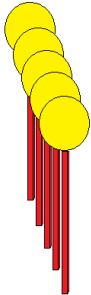
71	72
	
ACCEPTABLE	NOT ACCEPTABLE

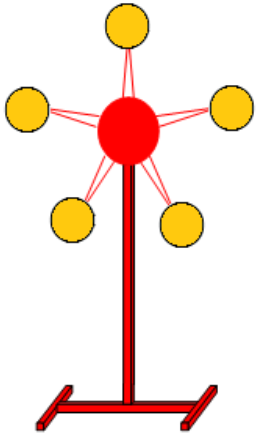
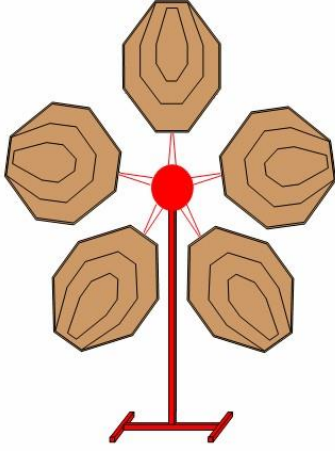
73	74
	
NOT ACCEPTABLE	NOT ACCEPTABLE

SECTION 5: Mixed Target Types and Size Arrays

5.1 The following types and sizes of targets must not be included together in the same target array: IPSC Targets and IPSC Mini Targets; or IPSC Poppers and IPSC Mini Poppers (see Rule 4.1.1.2)

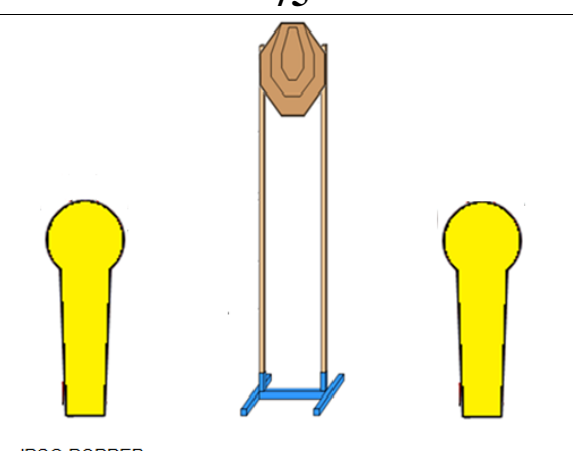
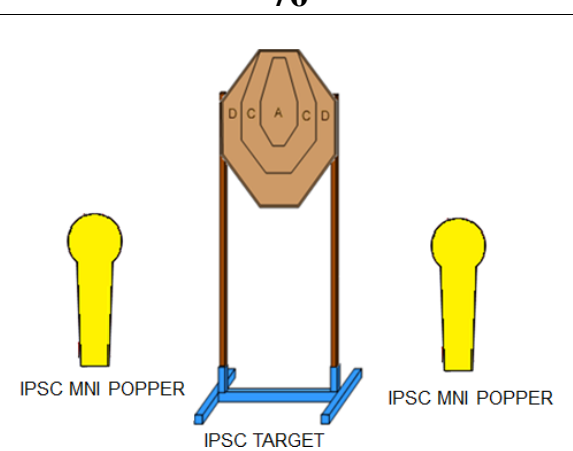
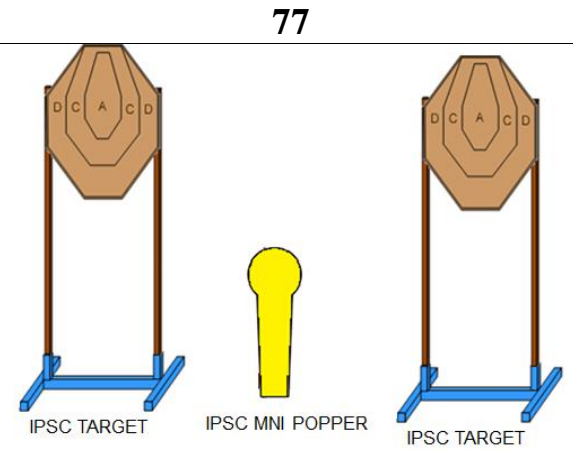
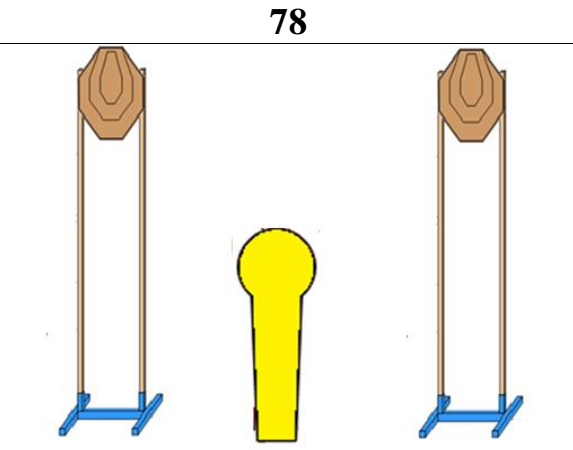
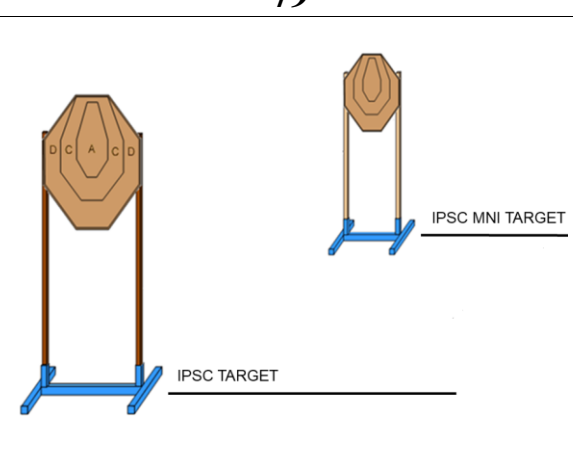
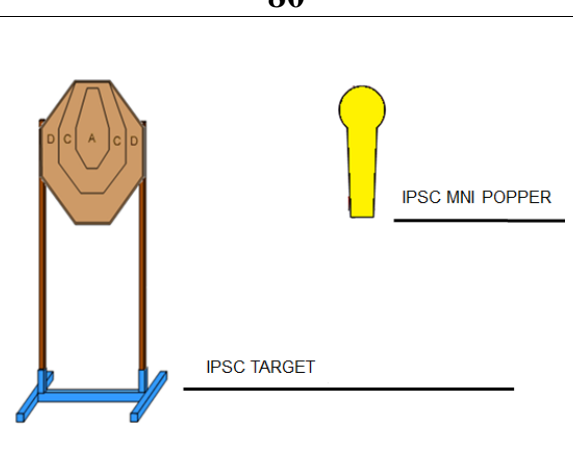
<p>75</p>  <p style="display: flex; justify-content: space-around; font-size: small;"> IPSC POPPER IPSC MINI TARGET IPSC POPPER </p> <p style="text-align: center;">ACCEPTABLE</p>	<p>76</p>  <p style="display: flex; justify-content: space-around; font-size: small;"> IPSC MINI POPPER IPSC TARGET IPSC MINI POPPER </p> <p style="text-align: center;">ACCEPTABLE</p>
<p>77</p>  <p style="display: flex; justify-content: space-around; font-size: small;"> IPSC TARGET IPSC MINI POPPER IPSC TARGET </p> <p style="text-align: center;">ACCEPTABLE</p>	<p>78</p>  <p style="display: flex; justify-content: space-around; font-size: small;"> IPSC MINI TARGET IPSC POPPER IPSC MINI TARGET </p> <p style="text-align: center;">ACCEPTABLE</p>
<p>79</p>  <p style="display: flex; justify-content: space-around; font-size: small;"> IPSC TARGET IPSC MINI TARGET </p> <p style="text-align: center;">NOT ACCEPTABLE</p>	<p>80</p>  <p style="display: flex; justify-content: space-around; font-size: small;"> IPSC TARGET IPSC MINI POPPER </p> <p style="text-align: center;">ACCEPTABLE</p>

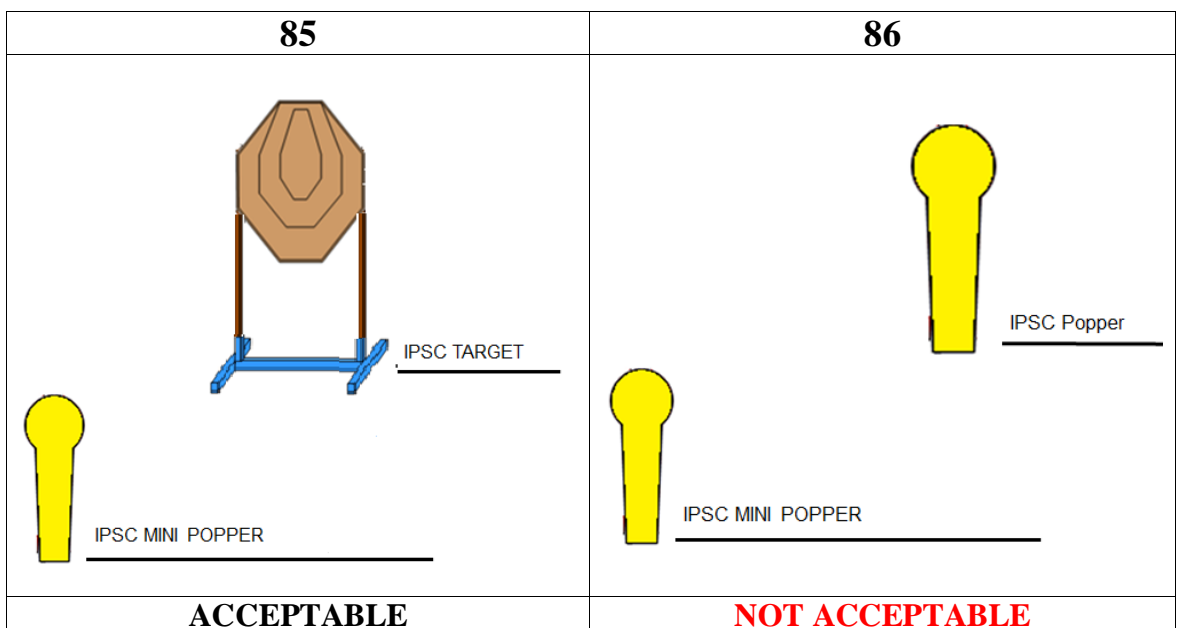
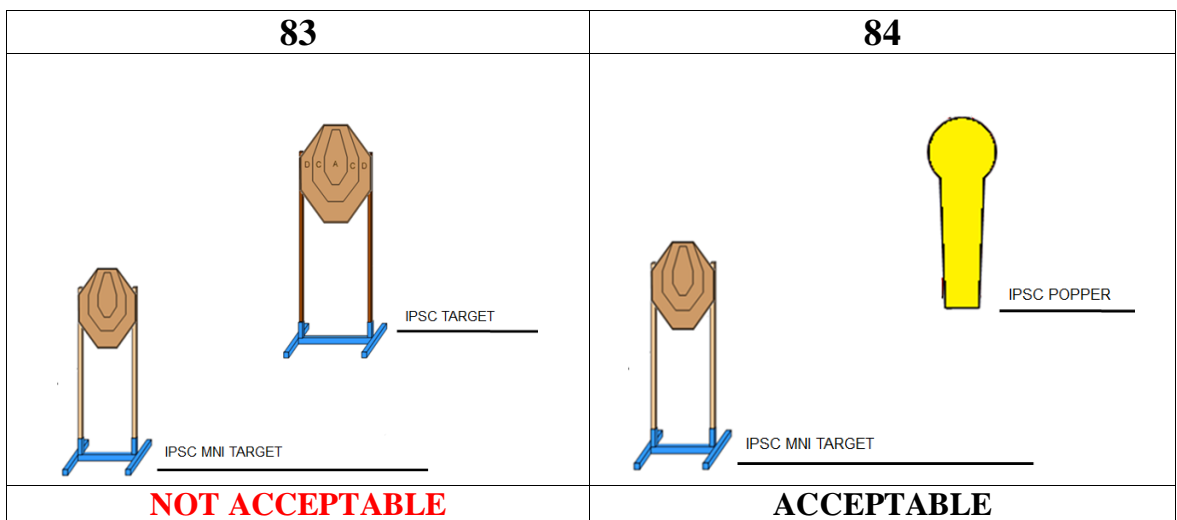
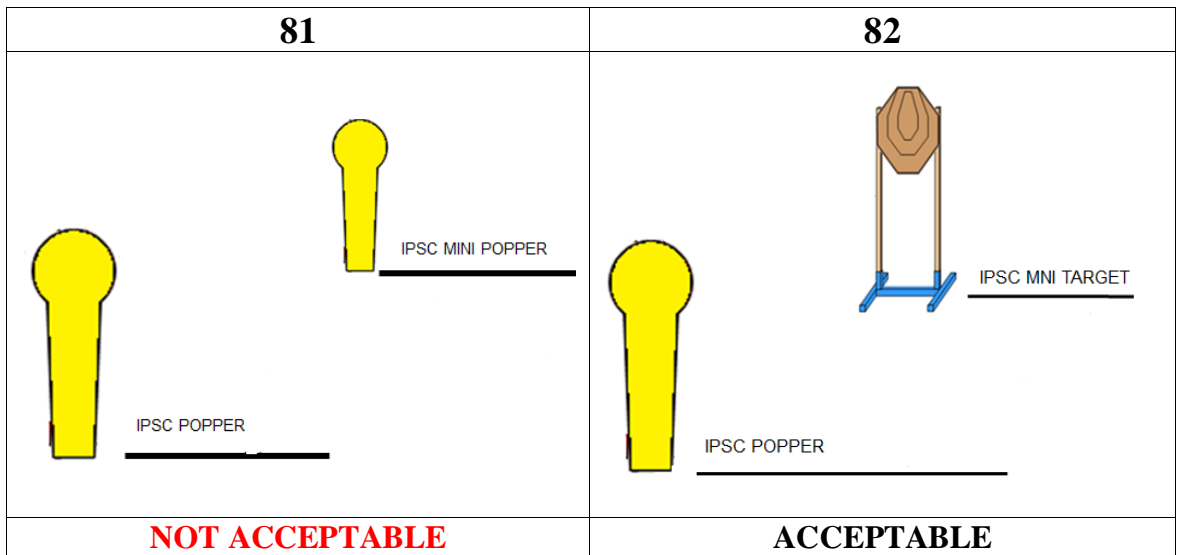

87	88
	<p>Intentionally Left Blank</p>
NOT ACCEPTABLE	

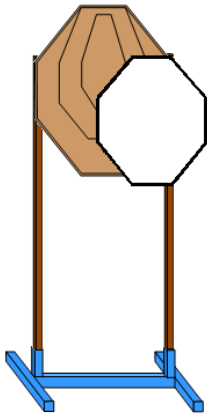
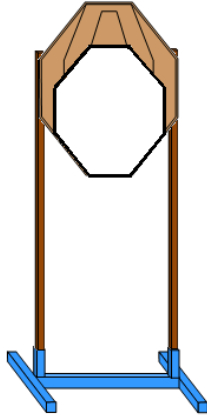
89	90
	
NOT ACCEPTABLE	NOT ACCEPTABLE

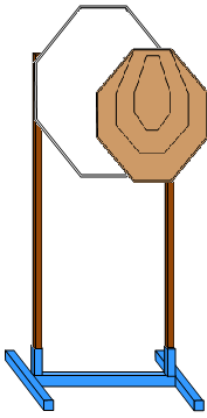
91	92
	<p>Intentionally Left Blank</p>
NOT ACCEPTABLE	